

AVENTOS Spring Tension Adjustment Instructions

ADJUSTMENT INSTRUCTIONS for AVENTOS

Any adjustment of Aventos Hardware must be done with the recommended bit. Using any other bit will nullify any hardware warranty.

Bit needed for adjustment will be included with every AVENTOS cabinet

Warning



Risk of severe injury by spring-loaded arm. DO NOT push arm down when door is not attached.



When installing or removing, ensure arm is left in "UP" position. It is recommended that arms are removed during cabinet installation.

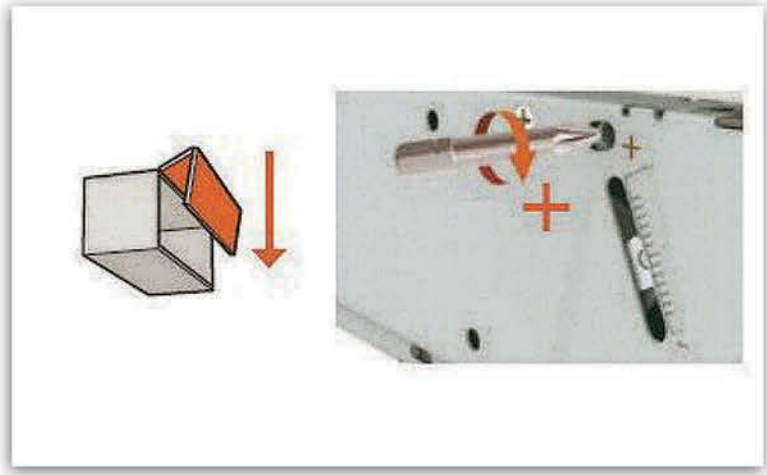
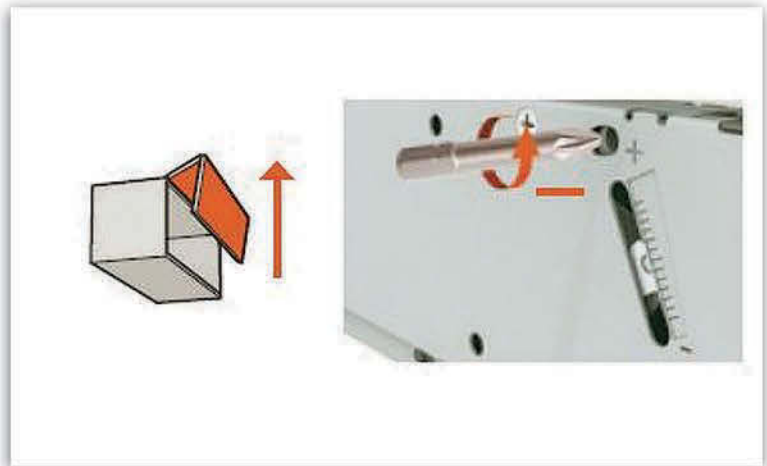
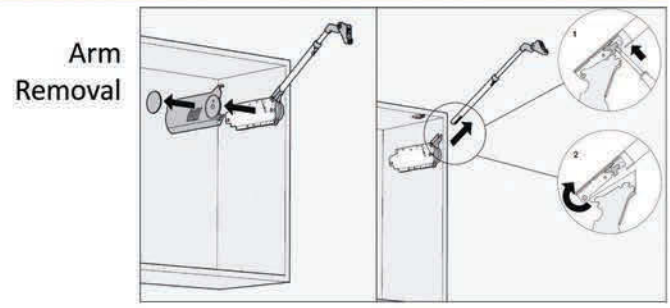

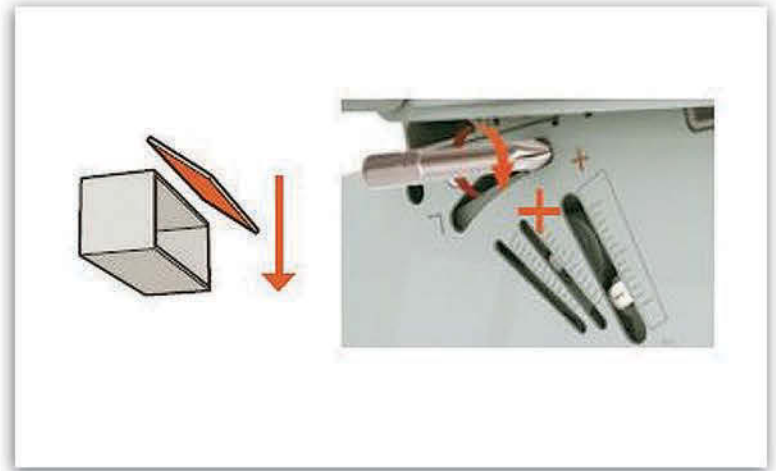
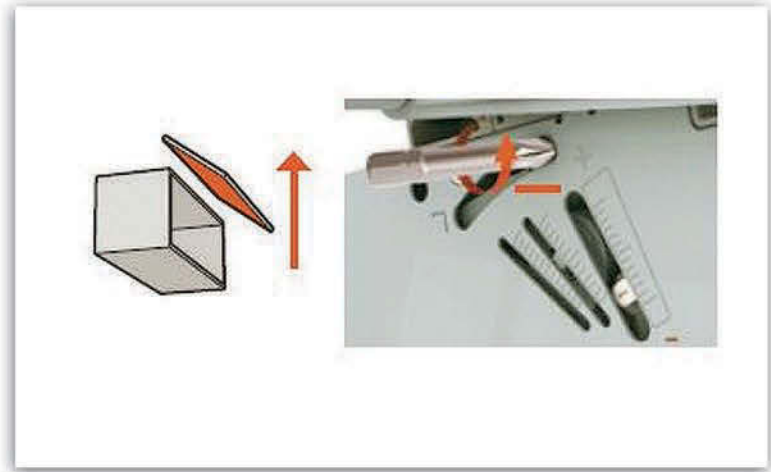

2

HS

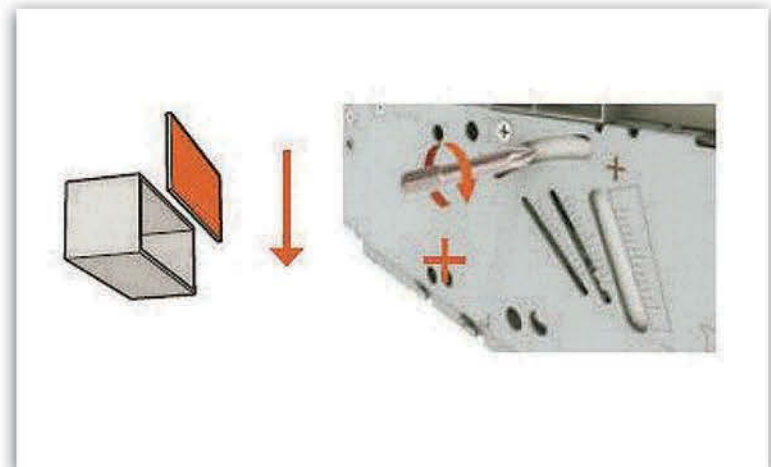
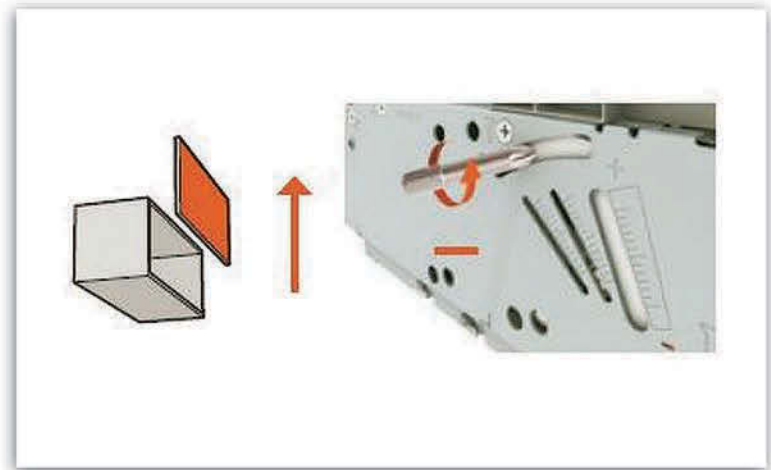

HL



Wall 1 Door Vertical Cabinet Aventos HL

Door Removal



Door Attachment

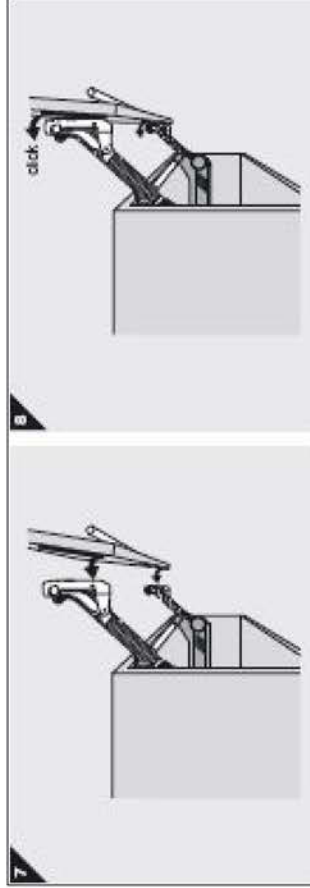

Tension Adjustment

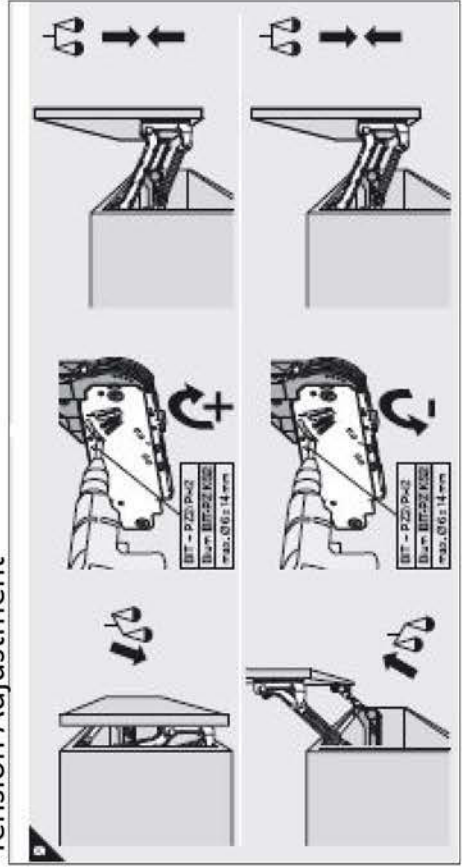

Wall 1 Door Horizontal 1 Door Up & Over Cabinet Aventos HS

Door Removal

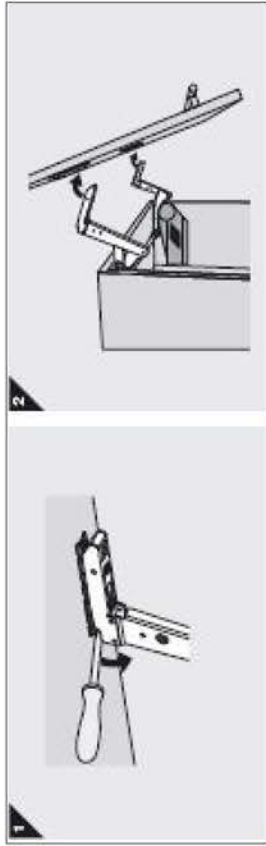

Door Attachment

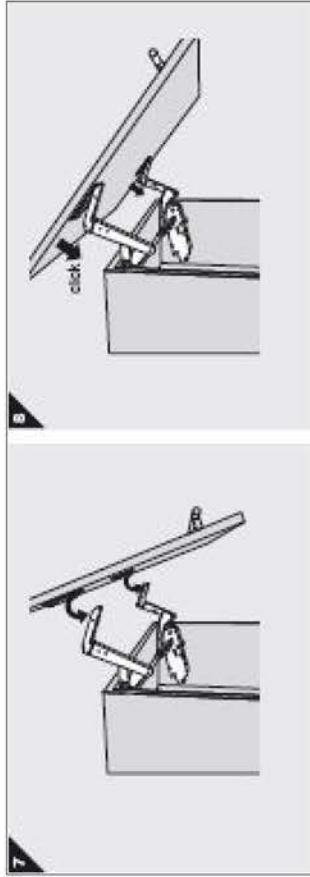

Tension Adjustment

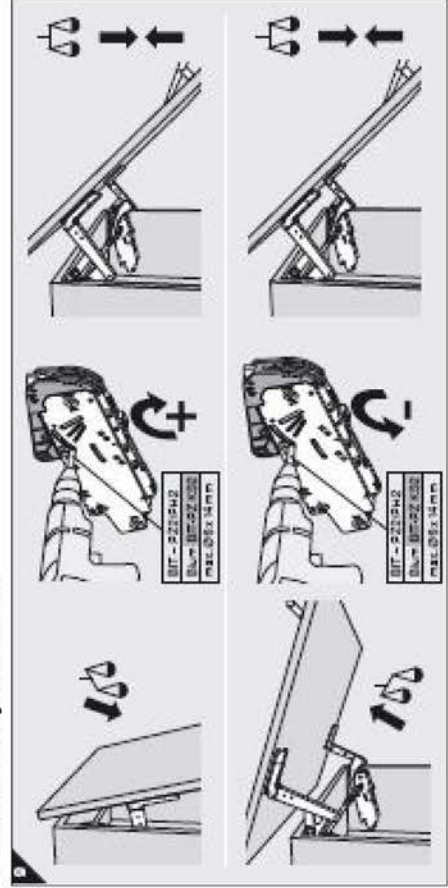

Wall 2 Door Horizontal Bi-Fold Cabinet Aventos HF

Door Removal

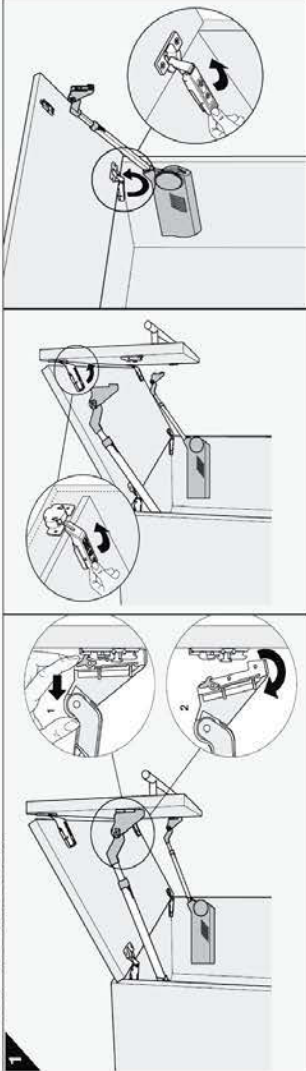

Door Attachment

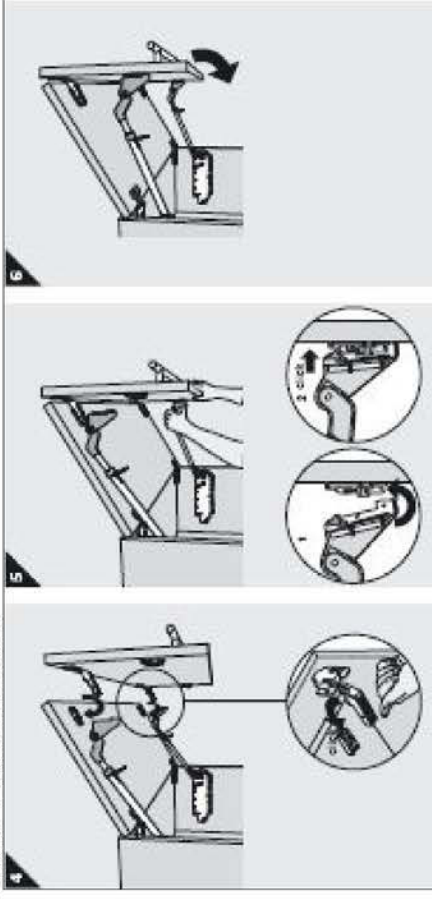

Tension Adjustment

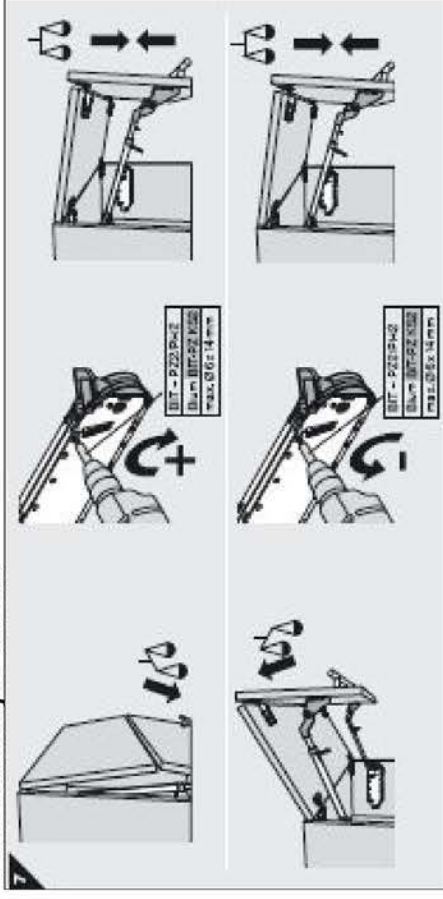

Opening angle stop for 104° : **20F7051**.

- For less required space above the cabinet.

Opening angle stop for 83° : **20F7011**.

- No required space above the cabinet.



Fix lift mechanism with an additional screw 4 x 35 mm!

